



COMBiLiFT

C4000E

Customised Handling Solution



New Display Including Wheel Position



Deep Suspension Seat



three machines in one

Counterbalance Forklift > Aisle Truck > Side Loader

Patent Pending : GB1302811.3

www.COMBiLiFT.com



SPECIFICATIONS

MODEL C4000E

Available 3,000 kg to 5,000 kg

REF	DESCRIPTION	C4000 E
1a	Max. Lift Height	4040mm
1b	Freelift Height	0mm
2	Height Mast Closed	2855mm
3	Max. (Mast raised)	4870mm
4	Overall Length	2300mm
5	Mast Travel	1300mm
6	Ground Clearance Under Mast	150mm
7	Ground Clearance to Centre of Wheelbase	180mm
8	Height Over Cab (Without work - lights)	2380mm
9	Width	2270mm
10	Outside Spread of Fork Arms	1350mm
11	Track Front	2020mm
12	Frame Opening	1400mm
13	Load Centre Distance	600mm
14	Overhang Front	220mm
15	Wheelbase	1895mm
16	Overhang Back	135mm
17	Length From Face of Fork	1100mm
18	Approach Angle	45°
19	Ramp Angle	17°
20	Departure Angle	45°
21	Forward Tilt	3°
22	Backward Tilt	5°
23	Minimum Outside Radius	1785mm
24	Platform Height	470mm
25	Platform Length	1200mm
A	Capacity	4000kg
B	Unladen Weight	6650kg
C	Maximum Ground Speed	10km/h
D	Gradability	10%
E	Battery Capacity (V / Ah)	80V / 620Ah
F	Fork Section	50mm x 150mm x 1200mm
G	405/220-305 Front Tyres (Solid Rubber)	OD 405mm / Width 220mm
H	27 x 10-12 Rear Tyre	OD 680mm / Width 255mm
I	Standard Colour	Green & Grey
J	AC Electric Traction Motor x 2	80v / 5kW
K	AC Electric Pump Motor	80V / 19kW

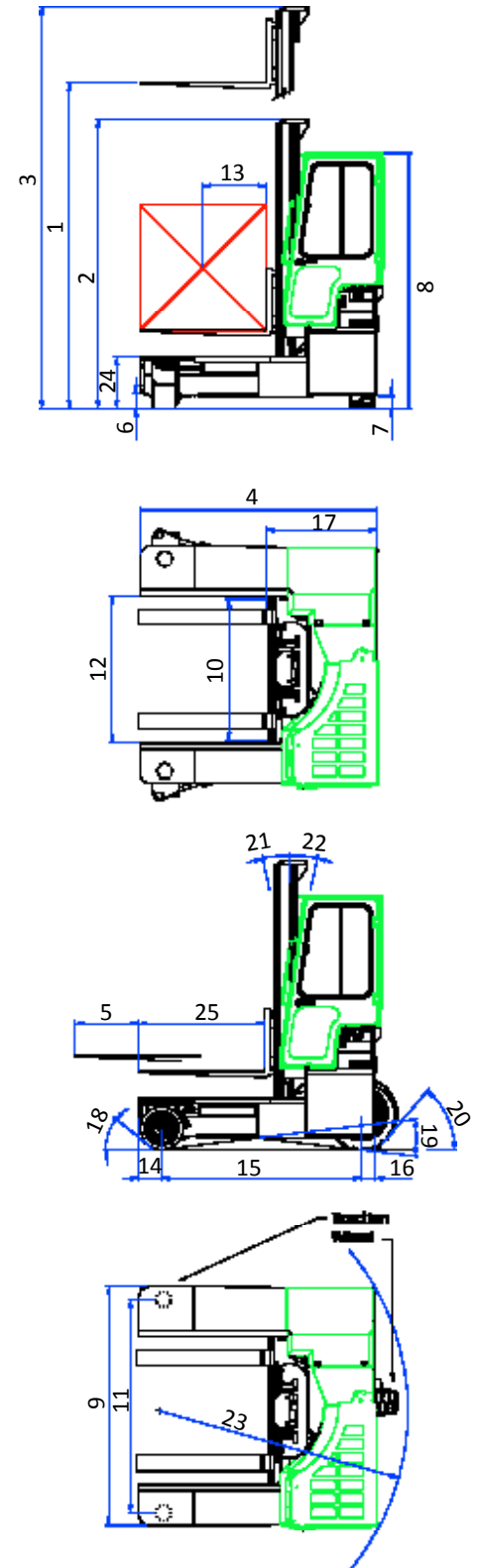

FEATURES INCLUDE:

- Rubber Mounted Cabin
- AC Motor Technology
- Multi-Direction Operation
- Load Sensing Steering
- Curtis AC Software
- 4 Way Lever Positioning of Wheels
- 2 Wheel Drive

Distributed by:

COMBiLiFT

Co. Monaghan
Ireland

T: +353 47 80500

F: +353 47 80501

E: info@combilift.com

www.COMBiLiFT.com